

PART NUMBER

CSW1VP1WH

MODEL DESCRIPTION

Switch 1G, 16A, Vertical, Provision to Mount Mech, White

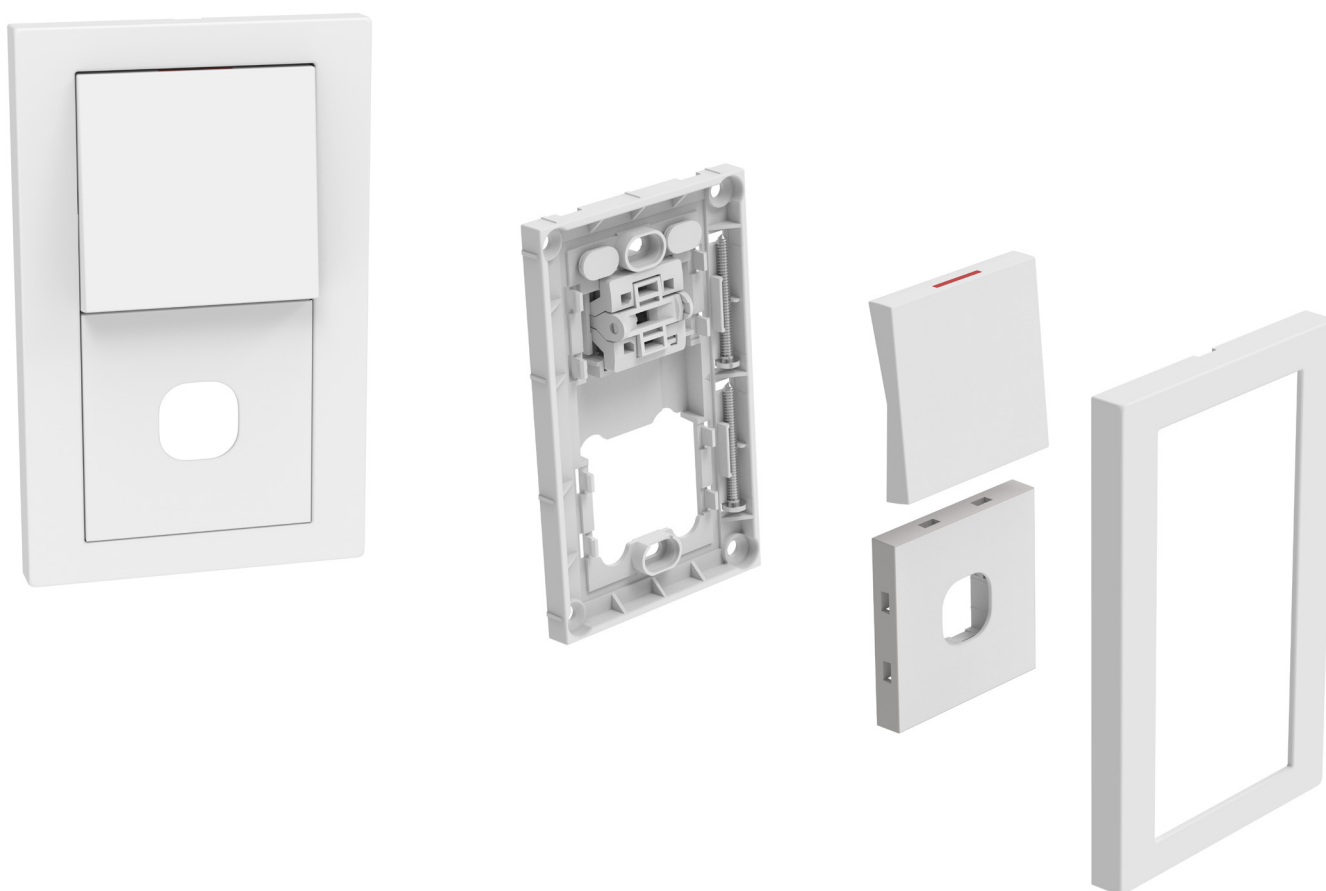
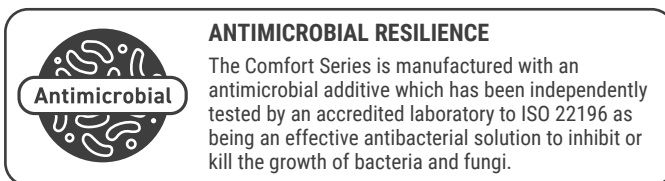

TECHNICAL DATA

PART NUMBER	CSW1VP1WH
DESCRIPTION	Switch 1G, 16A, Vert, Provision to Mount Mech, White
COLOUR	White
MOUNTING CENTRE	84mm
PLATE SIZE	Standard
COMPLIANCE	AS/NZS 3133, ISO 22196, AS 1428.1 - Design for access and mobility, Livable Housing Design Guidelines – Switches & Powerpoints (Platinum Level)

DIMENSIONS

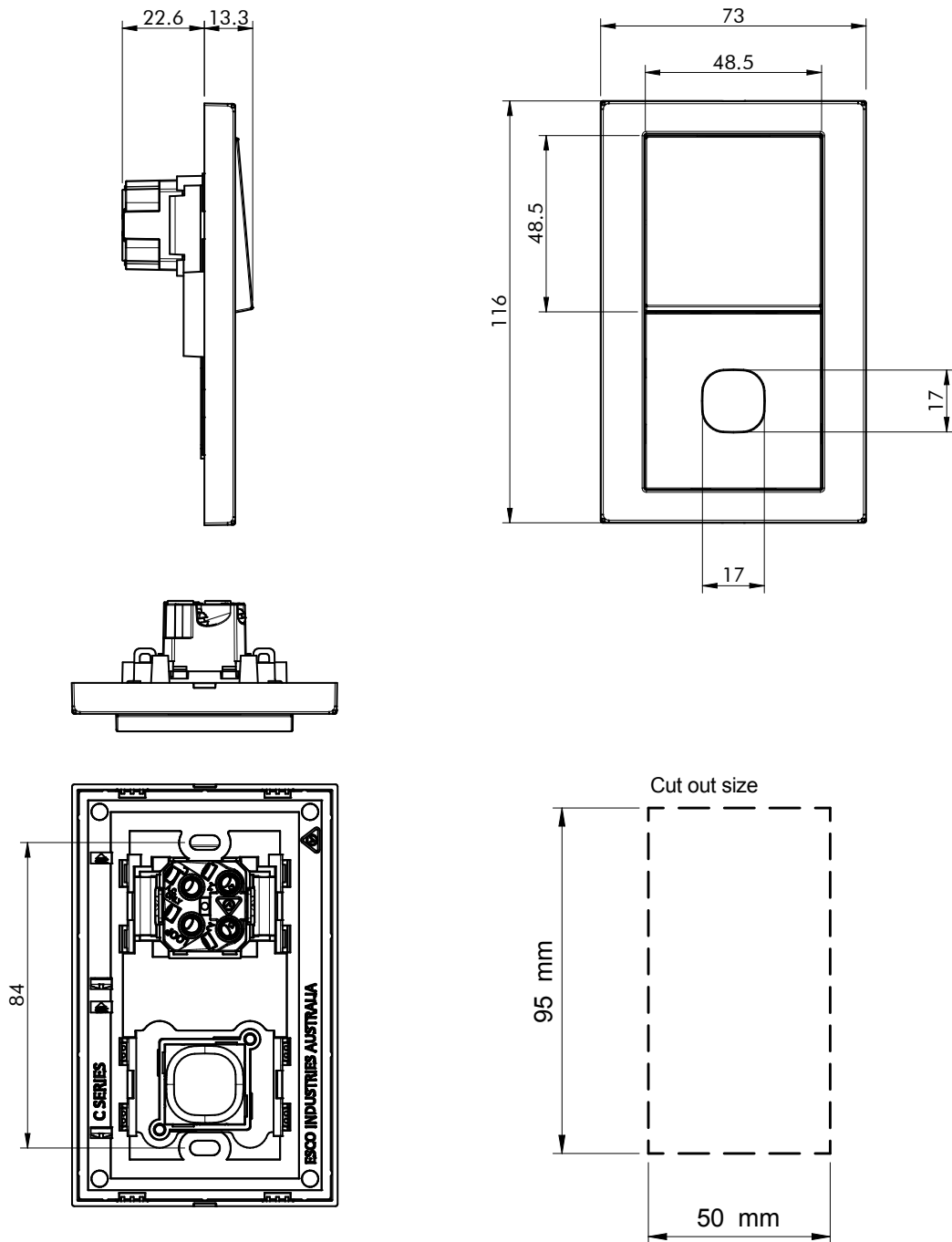

esco
industries

THE ESCO GROUP OF COMPANIES

esco MASRAP **MediTek**
industries

modempak

ESCO INDUSTRIES

89 Egerton St (Cnr Fariola & Egerton)
 PO Box 6193, Silverwater
 NSW 2128 AUSTRALIA

MODEMPAK NZ

Unit 11/273 Neilson St, Onehunga
 AUCKLAND 1061 NEW ZEALAND

T 1300 879 363 F 1300 879 364

customer.service@escoindustries.com.au
 www.escoindustries.com.au

D +64 9 526 1880 **Freecall** 0800 663 367

customer.service@modempak.co.nz
 www.modempak.co.nz

PART NUMBER

CSWF3P1LWH

MODEL DESCRIPTION

Switch 3G Full Plate, 16A, Provision To Mount Mech LHS, White

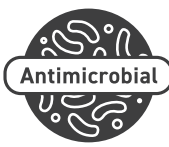

ANTIMICROBIAL RESILIENCE

The Comfort Series is manufactured with an antimicrobial additive which has been independently tested by an accredited laboratory to ISO 22196 as being an effective antibacterial solution to inhibit or kill the growth of bacteria and fungi.



TECHNICAL DATA

PART NUMBER	CSWF3P1LWH
DESCRIPTION	Switch 3G Full Plate, 16A, Provision To Mount Mech LHS, White
COLOUR	White
MOUNTING CENTRE	84mm
PLATE SIZE	Large
COMPLIANCE	AS/NZS 3133, ISO 22196, AS 1428.1 - Design for access and mobility, Livable Housing Design Guidelines – Switches & Powerpoints (Platinum Level)

DIMENSIONS

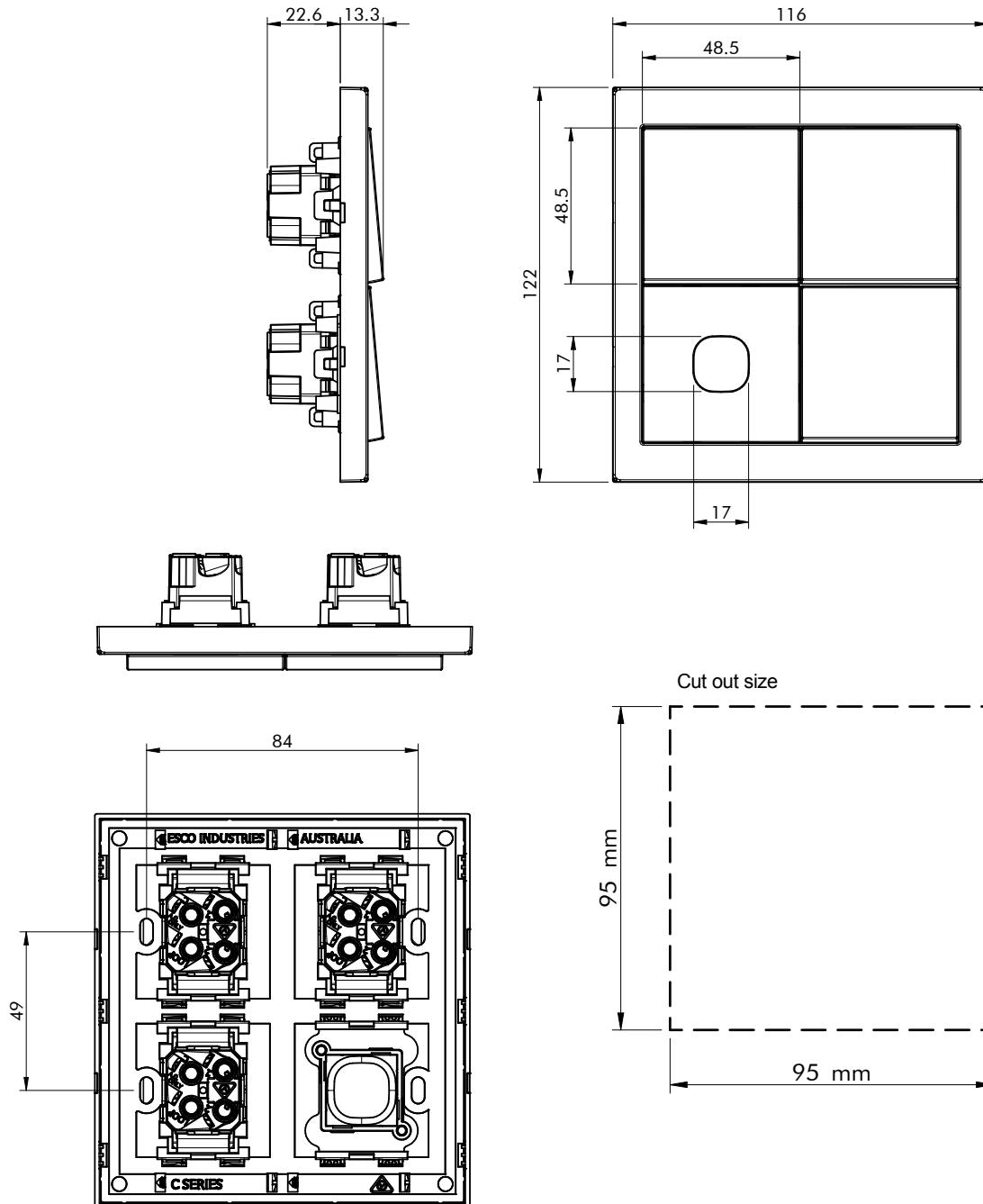

esco
industries

THE ESCO GROUP OF COMPANIES

esco industries MASRAP **MediTek**

modempak

ESCO INDUSTRIES

89 Egerton St (Cnr Fariola & Egerton)
PO Box 6193, Silverwater
NSW 2128 AUSTRALIA

T 1300 879 363 F 1300 879 364

customer.service@escoindustries.com.au
www.escoindustries.com.au

MODEMPAK NZ

Unit 11/273 Neilson St, Onehunga
AUCKLAND 1061 NEW ZEALAND

D +64 9 526 1880 **Freecall** 0800 663 367

customer.service@modempak.co.nz
www.modempak.co.nz

PART NUMBER

CSWF3P1RWH

MODEL DESCRIPTION

Switch 3G Full Plate, 16A, Provision To Mount Mech RHS, White

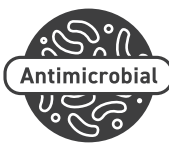

ANTIMICROBIAL RESILIENCE

The Comfort Series is manufactured with an antimicrobial additive which has been independently tested by an accredited laboratory to ISO 22196 as being an effective antibacterial solution to inhibit or kill the growth of bacteria and fungi.

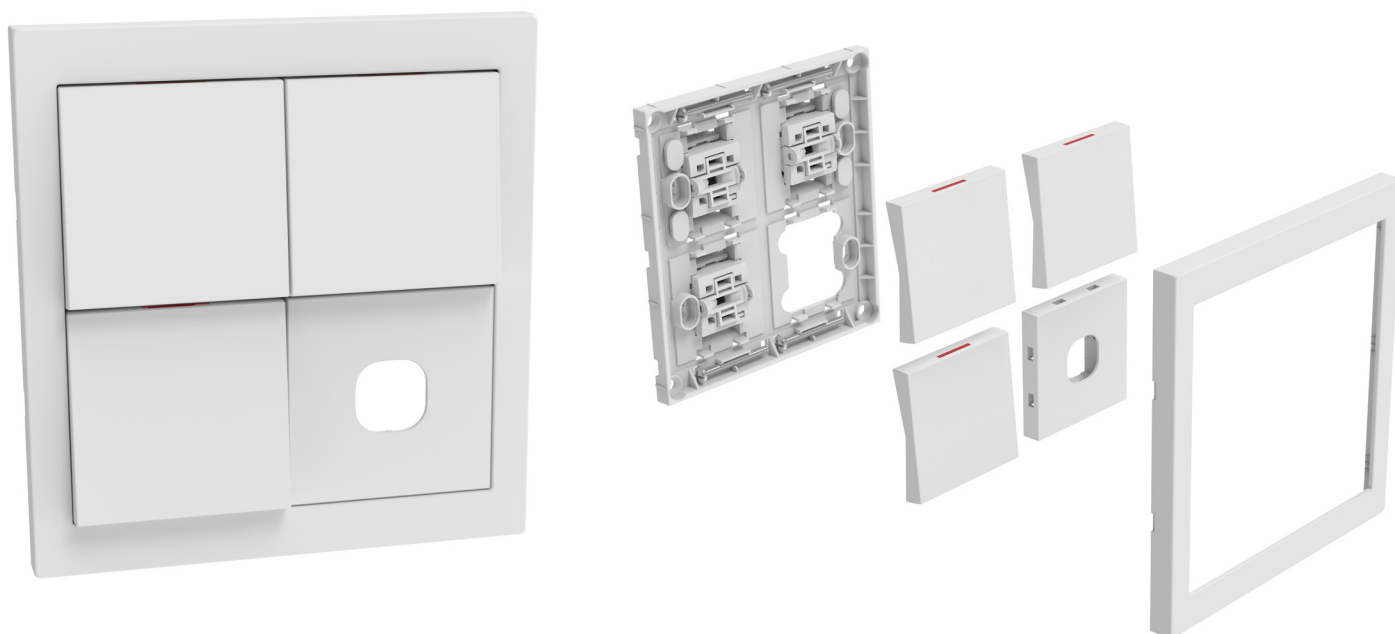

TECHNICAL DATA

PART NUMBER	CSWF3P1RWH
DESCRIPTION	Switch 3G Full Plate, 16A, Provision To Mount Mech RHS, White
COLOUR	White
MOUNTING CENTRE	84mm
PLATE SIZE	Large
COMPLIANCE	AS/NZS 3133, ISO 22196, AS 1428.1 - Design for access and mobility, Livable Housing Design Guidelines – Switches & Powerpoints (Platinum Level)

DIMENSIONS

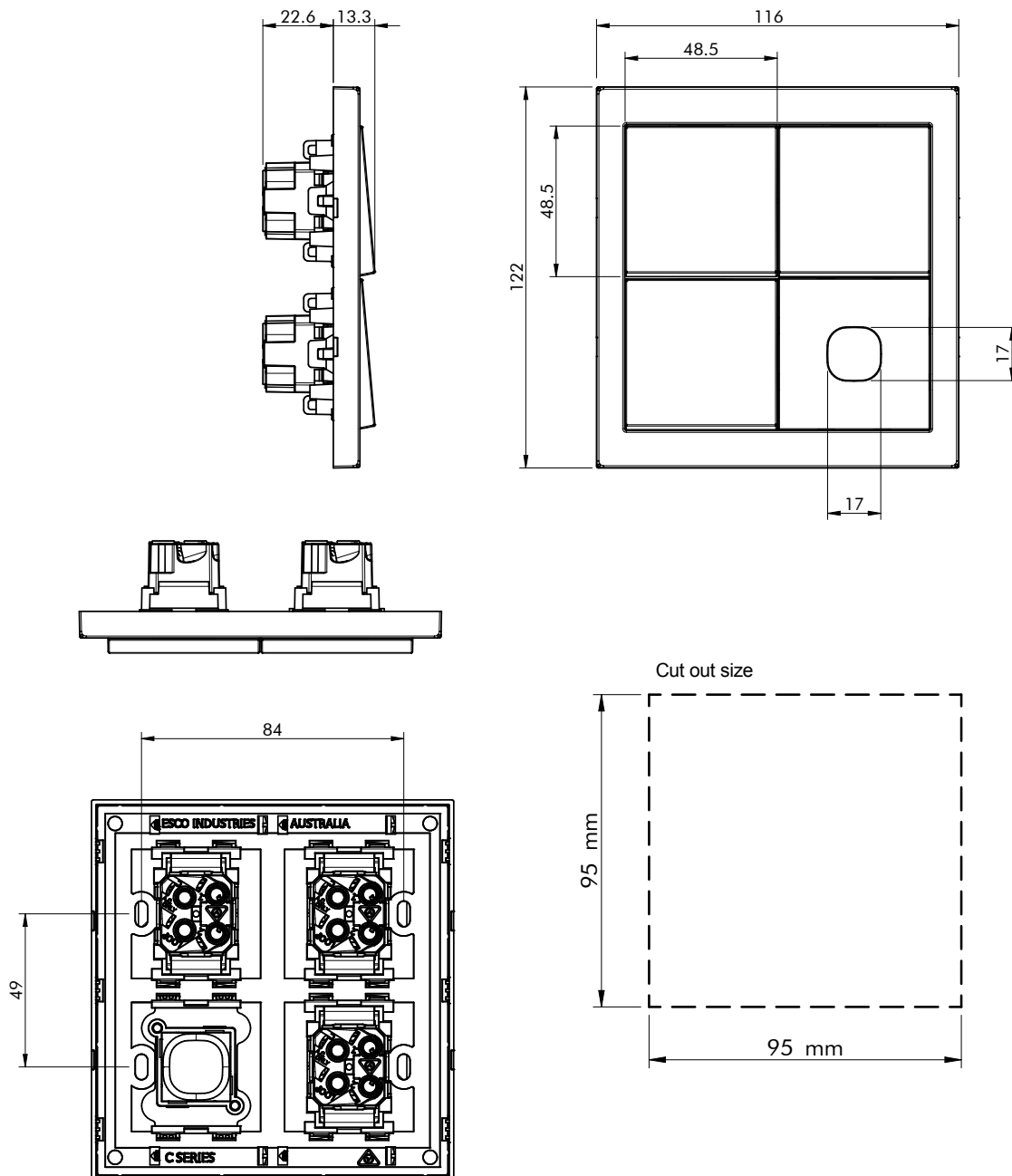

esco
industries

THE ESCO GROUP OF COMPANIES

esco industries MASRAP **MediTek**

modempak

ESCO INDUSTRIES

89 Egerton St (Cnr Fariola & Egerton)
PO Box 6193, Silverwater
NSW 2128 AUSTRALIA

MODEMPAK NZ

Unit 11/273 Neilson St, Onehunga
AUCKLAND 1061 NEW ZEALAND

T 1300 879 363 F 1300 879 364

customer.service@escoindustries.com.au
www.escoindustries.com.au

D +64 9 526 1880 Freecall 0800 663 367

customer.service@modempak.co.nz
www.modempak.co.nz

PART NUMBER

CSWF2P2WH

MODEL DESCRIPTION

Switch 2G Full Plate, 16A, Provision To Mount Mech x 2, White

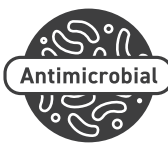

ANTIMICROBIAL RESILIENCE

The Comfort Series is manufactured with an antimicrobial additive which has been independently tested by an accredited laboratory to ISO 22196 as being an effective antibacterial solution to inhibit or kill the growth of bacteria and fungi.

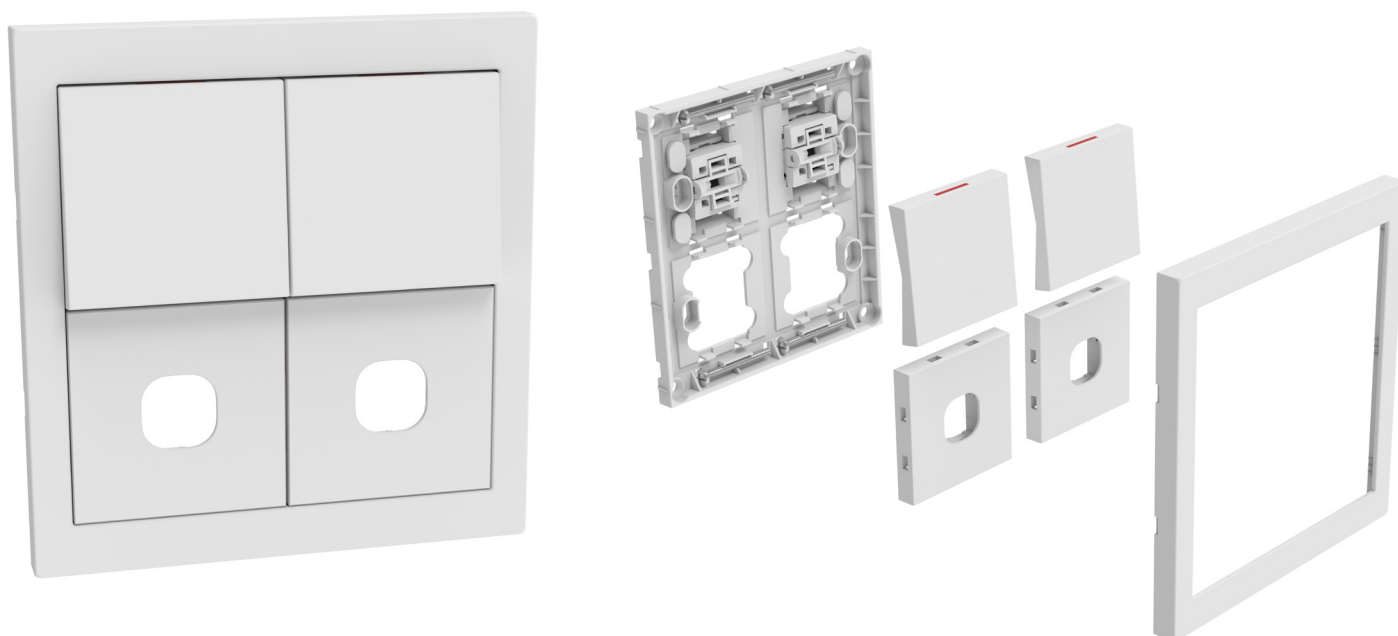

TECHNICAL DATA

PART NUMBER	CSWF2P2WH
DESCRIPTION	Switch 2G Full Plate, 16A, Provision To Mount Mech x 2, White
COLOUR	White
MOUNTING CENTRE	84mm
PLATE SIZE	Large
COMPLIANCE	AS/NZS 3133, ISO 22196, AS 1428.1 - Design for access and mobility, Livable Housing Design Guidelines – Switches & Powerpoints (Platinum Level)

DIMENSIONS

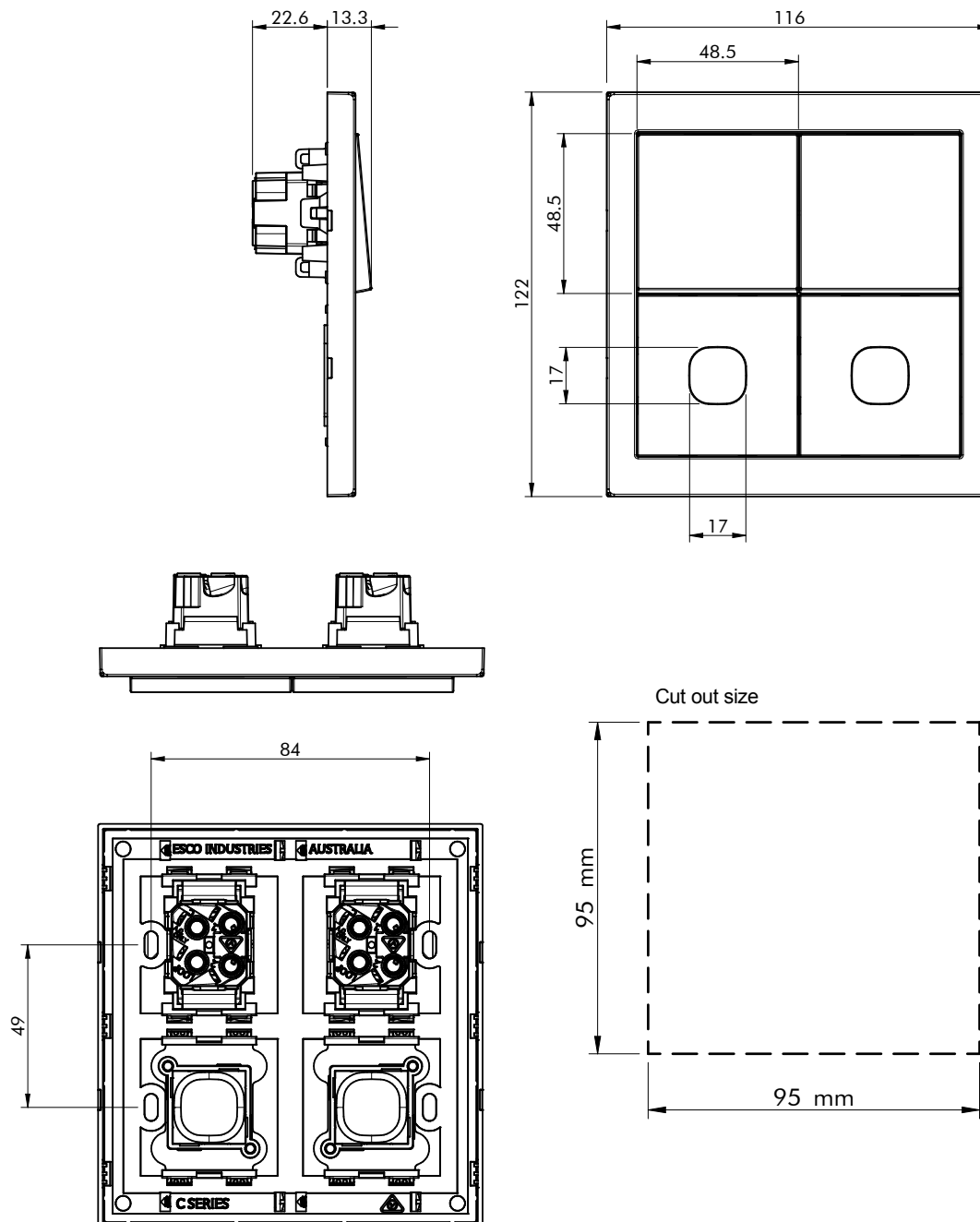

esco
industries

THE ESCO GROUP OF COMPANIES

esco industries MASRAP **MediTek**

modempak

ESCO INDUSTRIES

89 Egerton St (Cnr Fariola & Egerton)
PO Box 6193, Silverwater
NSW 2128 AUSTRALIA

MODEMPAK NZ

Unit 11/273 Neilson St, Onehunga
AUCKLAND 1061 NEW ZEALAND

T 1300 879 363 F 1300 879 364

customer.service@escoindustries.com.au
www.escoindustries.com.au

D +64 9 526 1880 **Freecall** 0800 663 367

customer.service@modempak.co.nz
www.modempak.co.nz